

UM10386

SSL2102 19 W to 22 W mains dimmable LED driver

Rev. 2 — 1 February 2011

User manual

Document information

Info	Content
Keywords	SSL2102, LED driver, AC/DC conversion, dimmable, driver, mains supply, user manual.
Abstract	This is a user manual for the SSL2102 mains dimmable 19 W to 22 W LED driver demo board.



Revision history

Rev	Date	Description
v.2	20110201	second issue Modification: <ul style="list-style-type: none">• Figure 8 - pin names corrected
v.1	24-01-2011	first issue

1. Introduction

WARNING

Lethal voltage and fire ignition hazard



The non-insulated high voltages that are present when operating this product, constitute a risk of electric shock, personal injury, death and/or ignition of fire.

This product is intended for evaluation purposes only. It shall be operated in a designated test area by personnel qualified according to local requirements and labor laws to work with non-insulated mains voltages and high-voltage circuits. This product shall never be operated unattended.

The SSL2102 19 W to 22 W LED driver is a solution for a professional application with multiple high power LEDs that requires galvanic isolation and a safe output voltage. It is mains dimmable for both forward phase (triac) dimmers, and reverse phase (transistor) dimmers. It can generate up to 22 W output power, which is equal to a 150 W incandescent lamp (at 63 Lumen/W). Examples are shelf lighting, down lighting, LED lighting for bathrooms etc. The design gives an example of how to make a driver that is suitable for small form factor applications such as retrofit lamps.

2. Safety warning

The board needs to be connected to mains voltage. Touching the reference board during operation must be avoided at all times. An isolated housing is obligatory when used in uncontrolled, non-laboratory environments. Even though the secondary circuit with LED connection has a galvanic isolation, this isolation is not according to any regulated norm. Galvanic isolation of the mains phase using a variable transformer is always recommended. These devices can be recognized by the symbols shown in [Figure 1](#):

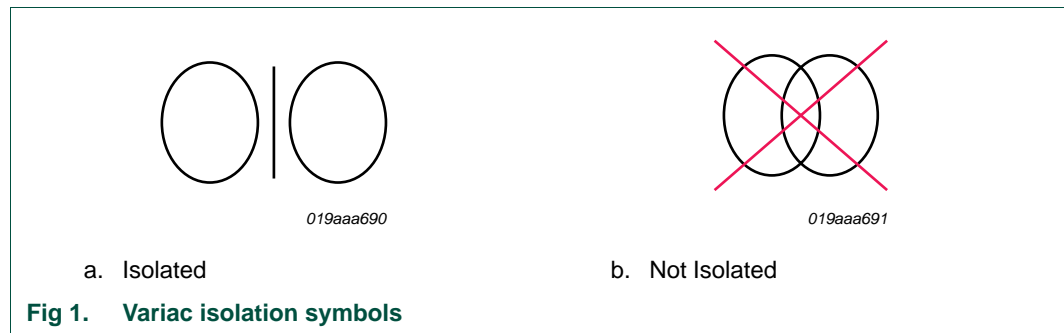

3. Connecting the board

Remark: All components referred to in the text can be located on [Figure 8 “Board schematic diagram”](#) and connectors can be found on [Figure 2 “Board connection diagram”](#).

The board can be optimized for a 230 V 50 Hz or a 120 V 60 Hz mains supply. In addition to the mains voltage optimization, the board is designed to work with multiple high power LEDs with a total working voltage of between 9 V and 23 V. The output current can be limited using trimmer R20. A dedicated LED load that is to be connected to K3 can be delivered on request. Connector K2 can be used to attach other LED loads. The output voltage is limited to 25 V. When attaching a LED load to an operational board (hot plugging) an inrush peak current will occur due to the discharge of capacitor C6. After frequent discharges, the LEDs may deteriorate or become damaged.

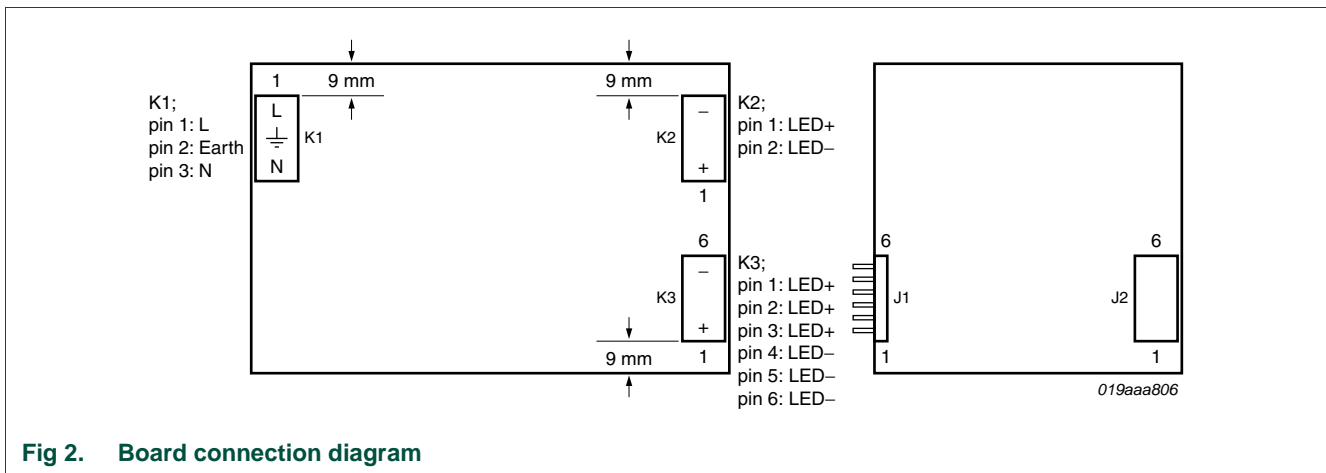

Fig 2. Board connection diagram

If a galvanically isolated transformer is used, it should be placed between the AC source and the dimmer/demo board. Connect a user defined LED (string) to connector K2 as shown in [Figure 2](#). Note that the anode of the LED (string) is connected to the bottom side of this connector.

Remark: When the board is placed in a metal enclosure, the middle pin of connector K1 should be connected to the metal casing for grounding.

4. Specifications

[Table 1](#) shows the specifications for the SSL2102 19 W to 22 W LED driver

Table 1. Specifications

Parameter	Value	Comment
AC line input voltage	85 V to 276 V	board has been optimized for 230 V, 50 Hz or 120 V, 60 Hz $\pm 10\%$ variation
DC output voltage (LED voltage)	9 V to 23 V	-
Output voltage protection	25 V (DC)	-
Output current (LED current)	400 mA to 1050 mA	adjustable with trimmer. The 120 V (AC) version is limited to 900 mA.
Output voltage /load current dependency	$< \pm 4\%$ / Volt in regulated range	see attached graphs in Section 12 "Appendix A - Load curves"
Current ripple	± 50 mA	at 500 mA
Maximum output power (LED power)	22 W	at $V_O + 21$ V. The 120 V (AC) version is limited to 19 W.
Efficiency	70 % to 78 %	at $T_{amb} = 25\text{ }^\circ\text{C}$ see attached graphs in Section 13 "Appendix B - Efficiency curves" graphs
Power Factor: 120 V, 60 Hz	0.99	at 19 W output power
230 V, 50 Hz	0.97	at 22 W output power
Switching frequency	60 kHz to 75 kHz	-
Dimming range	100 % to 0 %	-
Board dimensions	103 mm \times 50 mm \times 20 mm	length \times width \times height
Operating temperature	0 $^\circ\text{C}$ to 85 $^\circ\text{C}$	-
Isolation voltage	1.8 kV	between primary and secondary circuit
Input voltage / load current dependency	+5 % to -6 %	in the range of 130 V 60 Hz to 110 V 60 Hz
	+3 % to -3 %	in the range of 250 V 50 Hz to 210 V 50 Hz

5. Board photos

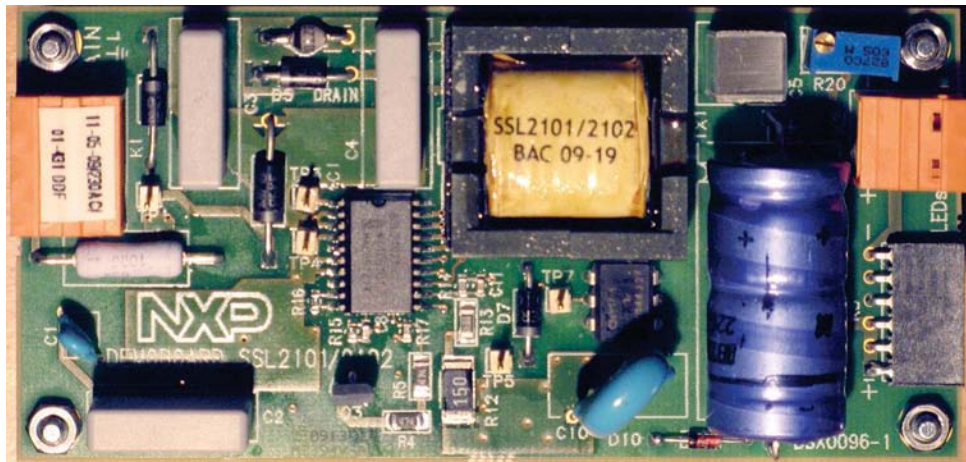

Fig 3. Demo board (top)

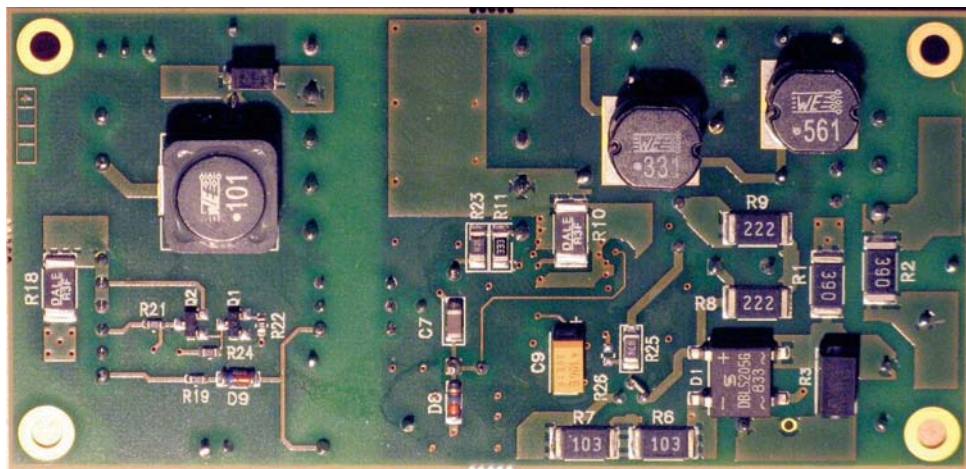

Fig 4. Demo board (bottom)

6. Dimmers

Several triac based dimmers have been tested by NXP Semiconductors. Because different dimmers have different specifications, the dimming performance of the board may vary. [Table 2](#) provides a list of dimmers that have currently been tested with the board:

Table 2. Dimmer selection

Manufacturer	Type	Voltage V (AC)	Power range (W)	Load	Min. dimming range (%)
Opus	852.390	230	60-400	Ha/Inc	0.6
Opus	852.392	230	20-500	Inc	0.05
Bush-Jaeger	2250U	230	20-600	Ha/Inc	0.03
Bush-Jaeger	2247U	230	20-500	Ha/Inc	0.07
Bush-Jaeger	6519U	230	40-550	Ha/Inc	8.4
Gira	1184	230	60-400	Inc	1
Everflourish	EFO700D	230	50-300	Ha/Inc	0.2
Drespa	0817	230	20-315	Ha/Inc	3.4
Ehmann	39 Domus	230	20-500	Ha/Inc	1
Drespa	815	230	20-500	Inc	1.1
Lutron	TG-600PH-WH	120	600	Inc	0 (off)
Levitron	L12-6641-W	120	600	Inc	0 (off)
Levitron	L02-700-W	120	600	Inc	0 (off)
Levitron	6602-IW	120	600	Inc	0 (off)
Levitron	6683-W	120	600	Inc	0 (off)
Levitron	R12-6631-LW	120	600	Inc	0 (off)
Cooper	6001	120	600	Inc	0 (off)
Lutron	MIR-600THW-WH	120	600	Ha/Inc	0.9

Two other switches are referred to as the weak bleeder (pin WBLEED) and the strong bleeder (pin SBLEED). When the voltage on these pins is below a certain value (typically 52 V) the SBLEED switch closes, providing a current path that loads the dimmer during zero voltage crossing. This resets the dimmer timer. When the voltage on either of these pins is above 52 V, and the voltage on the ISENSE pin is below -100 mV, the weak bleeder switch closes. This current is boosted using Q3 and it provides a current path that loads the dimmer when the converter draws insufficient current to stabilize the dimmer latching. While the strong bleeder will always switch, the weak-bleeder will not activate until the output power drops below 8 W. This happens when the LEDs are dimmed, or when the maximum LED power is tuned below 8 W. [Figure 6](#) and [Figure 7](#) represent bleeder voltage versus time in dimmed and undimmed position (low voltage = active).

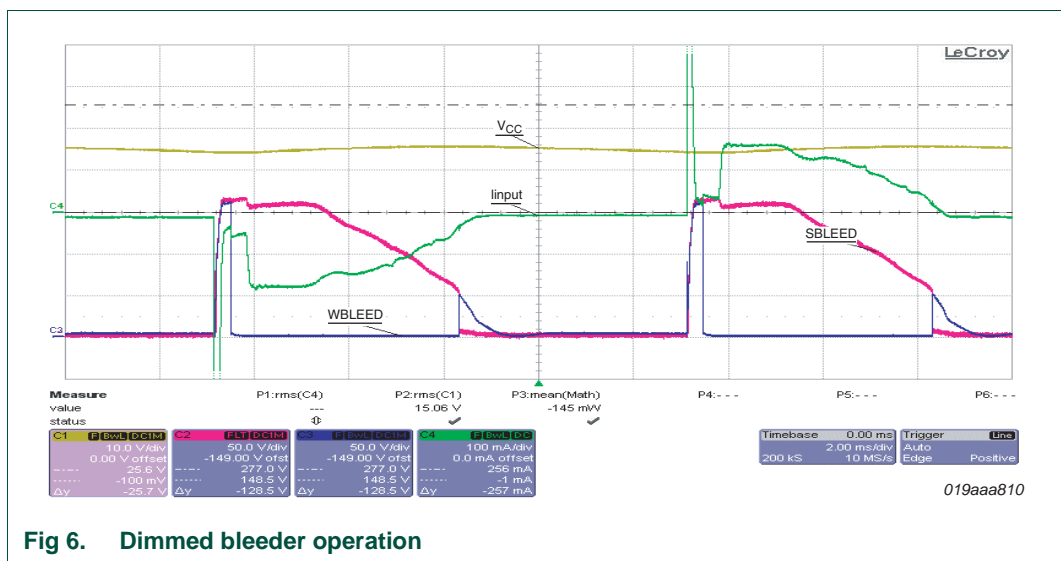

Fig 6. Dimmed bleeder operation

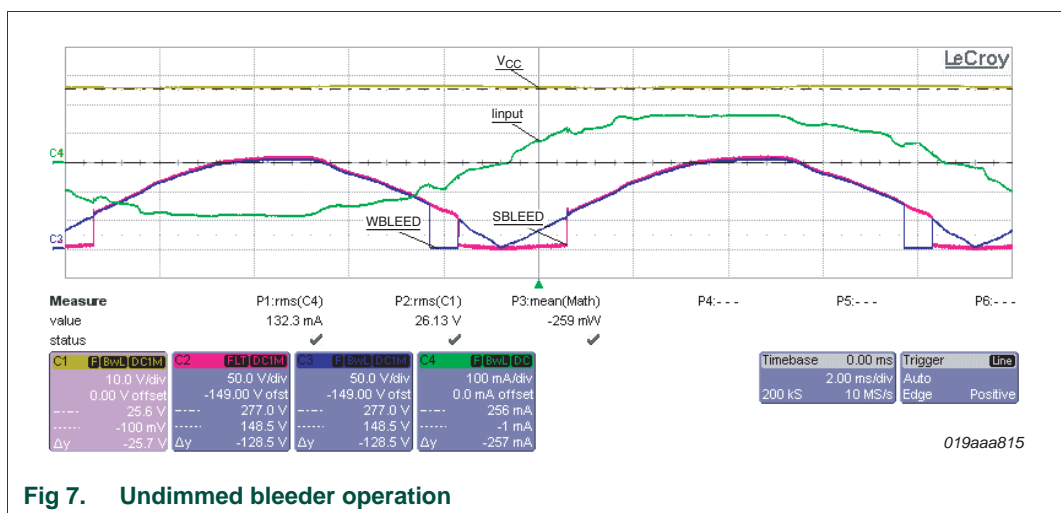

Fig 7. Undimmed bleeder operation

This board is optimized to work with a power factor above 0.9. In order to achieve this, the converter operates in constant t_{on} mode. The output power of the converter is buffered by capacitor C6. Due to this configuration, the circuit has a resistive input current behavior during undimmed operation (see input in [Figure 7](#)). During dimmed operation however, not only must the dimmer latch and hold current be maintained, but a damper must be added to dampen the inrush current and to dissipate the electric power that was stored in

the LC filter within the dimmer. A serial resistor can be used for this for low power ranges (<10 W) but for higher power ranges a single series resistor is not efficient. This is because the converter supply current will cause significant voltage drop and thus dissipation through this resistor. To improve efficiency, a combination of serial resistance and a parallel damper has been chosen for the demonstration board. The serial resistor is made up of F1, R1, R2 and R12 and the parallel damper comprises C2 and R3.

The input circuit of the converter must be equipped with a filter that is partially capacitive. The combination of C1, L1, L2, C3 and C4 makes a filter that blocks most of the disturbance generated by the converter input current. A drawback of this filter is a reduction of power factor, due to the capacitive load. A lower converter power, in relation to the capacitive value of this filter/buffer, will cause a lower power factor. The 230 V (AC) design uses 150 nF capacitors, which attain a power factor of 0.9 for an 11 W output power.

The board is equipped with a feedback loop that limits the output current. This feedback loop senses the LED current over sense resistor R18 and a current mirror is used, consisting of Q1 and Q2. The current level can be set using R20. The same feedback loop is also used for overvoltage protection. If the LED voltage exceeds 23 V, a current will flow through R19 and D9. The current through the opto-coupler IC2 will pull down the PWMLIMIT and BRIGHTNESS pin. The on-time is zero at a value below 400 mV. The feedback loop has proportional action only, and the gain is critical because of phase shift caused by the converter and C6. The relationship between PWMLIMIT and output current is quadratic in nature. The resultant output current spread will be acceptable for most LED applications.

The dimming range is detected by sensing the average rectified voltage. R4, R5 and R17 comprise a voltage divider, and C9 filters the resultant signal. The converter sets its duty factor and converter frequency accordingly.

8. Board optimization

The following modifications must be made in order to meet different customer application requirements:

Remark: All components referred to in the text can be located on [Figure 8 “Board schematic diagram”](#).

8.1 Changing the output voltage and LED current

Compared to other topologies, a flyback converter has the major advantage that it is suitable for driving a broader range of output voltages. Essentially, changing the winding ratio whilst maintaining the value of the primary inductance, will shift the output working voltage accordingly. Part of the efficiency of the driver is linked to the output voltage. A lower output voltage will increase the transformation ratio, and cause higher secondary losses. In practice, a mains dimmable flyback converter will have an efficiency of between 80 % for high output voltages (such as 60 V) down to 50 % for low output voltages (such as 3 V). Synchronous rectification might become advisable to reduce losses at low voltages. The NXP Semiconductors TEA1791 can be used for this purpose. For exact calculations of transformer properties and peak current, refer to application note AN10754, “SSL2101 dimmable mains LED driver”, and the calculation tool that is provided with it.

8.2 Changing the output ripple current

The output current ripple is principally determined by the LED voltage, the LED dynamic resistance and the output capacitor. The value of C6 has been chosen to optimize capacitor size with light output. A ripple of $\pm 25\%$ will result in an anticipated deterioration of light output of $<1\%$.

The size for the buffer capacitor can be estimated using the following equation:

$$C_{out} = \frac{I_{LED}}{\Delta I} \times \frac{I}{6 \times f_{net} \times R_{dynamic}} \quad (1)$$

Example:

For a ripple current of $\pm 5\%$, and a mains frequency of 50 Hz, and a dynamic resistance of 0.6Ω , C6 has to be $20 \div (300 \times 0.6) = 111$ mF. For a ripple current of 25% and a dynamic resistance of 6Ω , C6 has to be $4 \div (300 \times 6) = 2200$ μ F. Using a series of LEDs, the dynamic resistance of each LED can be added to the total dynamic resistance.

8.3 Adapting to high power reverse phase (transistor) dimmers.

Reverse phase (transistor) dimmers differ in two ways that can be beneficial but can also cause problems with dimming detection:

- The negative phase-cut (trailing edge) causes no inrush current when the dimmer triggers. When using triac dimmers, there will be a sudden voltage difference over the input leading to a steep charge of the input capacitors. The resultant peak current will lead to higher damper dissipation. Because this steep charge is missing, the input capacitors will have less stress, and the input circuit is less prone to audible noise.

Transistor dimmers contain active circuitry that require a load charge during the time that the dimmer is open. The dimensioning of the circuit generating the internal supply voltage inside the dimmer is made critical in order to avoid excessive internal dimmer losses. This means that the remaining voltage drop over the lamp must be low enough to reach this charge. For dimmers such as the Busch-Jaeger 6519U, the minimum lamp load is specified at 40 W which is equivalent to a 1.3 k Ω resistor load at 230 V(AC). Such a load would result in highly inefficient operation at low output power levels, since most energy is wasted in order to drive the dimmer, and not to produce light.

The value of the demo board weak bleeder (R6 and R7) is chosen to minimize losses (approximately 2 W to 3 W). The weak bleeder normally only switches on during dimmed operation. The voltage drop with some transistor dimmers is, however, not sufficient to cause full dimming range control (minimum 10 % instead of <1 %), because the average rectified voltage is used to determine the dimming position. To compensate for the reduced voltage difference, voltage detection can be made more sensitive by replacing R4 with a zener diode, such as the BZV85-C200 for 230 V (AC), or the BZV85-C68 for 120 V (AC) applications. Because of increased sensitivity, the dimming curve will also be steeper when using triac dimmers.

8.4 Changing the load curve

The load curve can be divided into two regions: one where the control loop limits the duty cycle of the converter, and where the output current is regulated, and another where the duty factor feedback is no longer dominant. This last part occurs at output voltages below 13 V. In this area, constant output power becomes the dominant control mechanism. Changing the turns ratio of the transformer to match the output load will also change the load curve.

8.5 Multiple driver support

It is possible to attach multiple converters to a single dimmer. When using triac dimmers the inrush current will rise, although not in proportion to the number of converters used. Transistor dimmers are more suitable for use with multiple converters because the dimming range will increase due to the added bleeder action, and there is no inrush current.

9. Board schematic

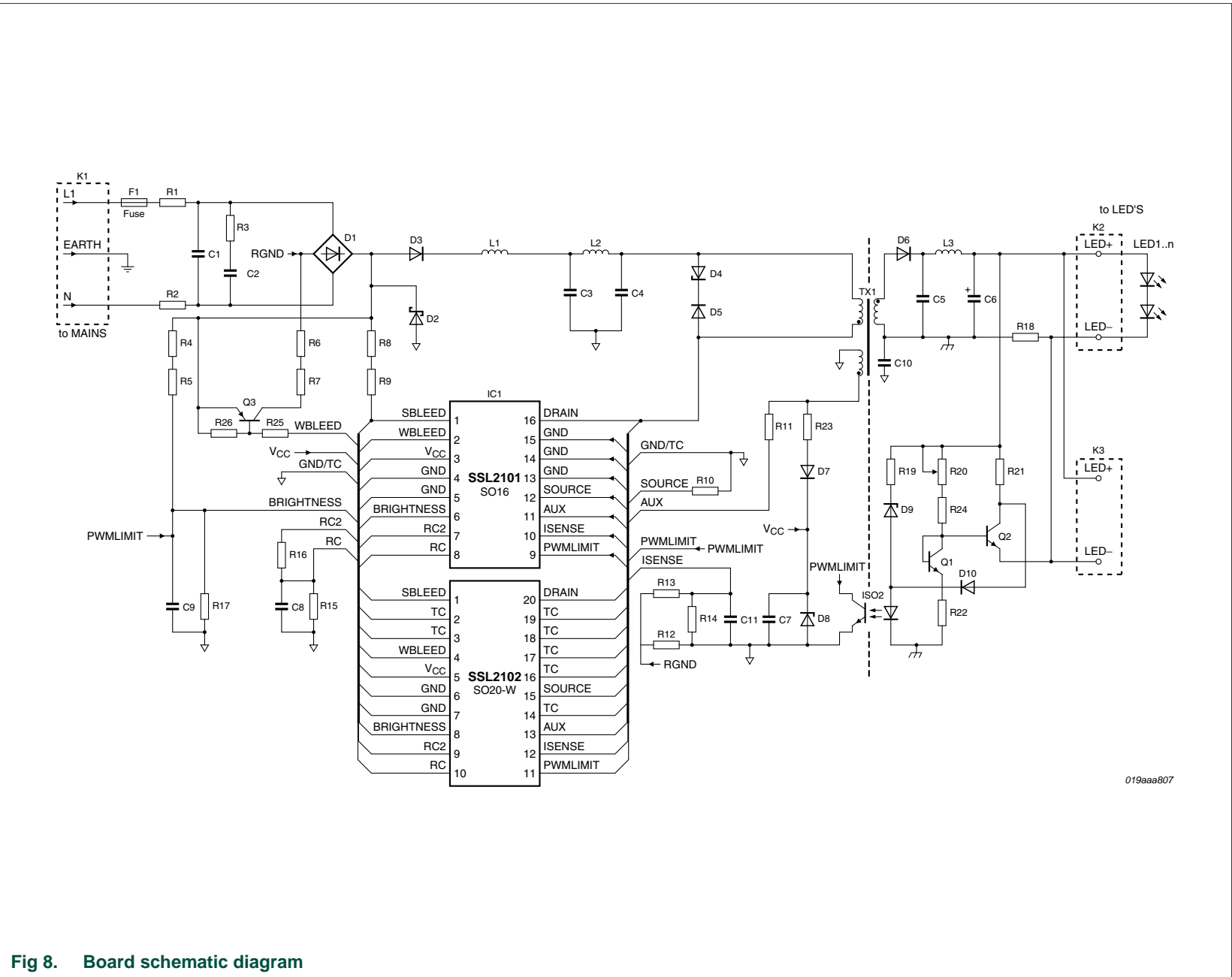

019aaa807

Fig 8. Board schematic diagram

10. Bill Of Materials (BOM)

Table 3. Bill of materials 230 V (AC)

Part No.	Ref.	Part	Value or part no.	Power (W)	Tol. (%)	Volt (V)	Package	Type	Manufacturer
1	K1	Conn 3 pin 2	m	-	-	-	-	SL 5.08/3/90	Weidmuller
2	K1'	Conn 3 pin 2	f	-	-	-	-	BL 5.08/3	Weidmuller
3	K3	Conn 6 pin 1	f	-	-	-	-	BL 3.36Z	Fischer
4	K2	Conn 2 pin 2	m	-	-	-	-	SL 5.08/2/90	Weidmuller
5	K2'	Conn 2 pin 2	f	-	-	-	-	BL 5.08/2	Weidmuller
6	F1	Fusistor	6.8 Ω	1	10	-	Free	-	-
7	R1	Resistor	39 Ω	1	5	-	Free	-	-
8	R2	Resistor	39 Ω	1	5	-	Free	-	-
9	R3	Resistor	1 k Ω	2	5	-	Free	-	-
10	R4	Resistor	470 k Ω	0.25	1	-	Free	-	-
11	R5	Resistor	470 k Ω	0.25	1	-	Free	-	-
12	R6	Resistor	10 k Ω	1	5	200	Free	-	-
13	R7	Resistor	10 k Ω	1	5	200	Free	-	-
14	R8	Resistor	2.2 k Ω	1	5	200	Free	-	-
15	R9	Resistor	2.2 k Ω	1	5	200	Free	-	-
16	R10	Resistor	0.4 Ω	1	1	-	Free	-	-
17	R11	Resistor	33 k Ω	0.25	5	200	Free	-	-
18	R12	Resistor	15 Ω	1	5	200	Free	-	-
19	R13	Resistor	100 k Ω	0.1	1	200	Free	-	-
20	R14	Resistor	22 k Ω	0.1	1	-	Free	-	-
21	R15	Resistor	470 k Ω	0.1	1	-	Free	-	-
22	R16	Resistor	4.7 k Ω	0.1	1	-	Free	-	-
23	R17	Resistor	12 k Ω	0.1	1	-	Free	-	-
24	R18	Resistor	0.3 Ω	1	1	-	Free	-	-
25	R19	Resistor	10 k Ω	0.1	5	-	Free	-	-
26	R20	Resistor	50 k Ω Lin	0.1	5	-	Horizontal	-	Bourns
27	R21	Resistor	22 k Ω	0.1	1	-	Free	-	-
28	R22	Resistor	330 Ω	0.1	1	-	Free	-	-
29	R23	Resistor	470 Ω	0.25	5	-	Free	-	-
30	R24	Resistor	3.9 k Ω	0.1	5	-	Free	-	-
31	R25	Resistor	470 k Ω	0.25	5	-	Free	-	-
32	R26	Resistor	10 k Ω	0.1	5	-	Free	-	-
33	C1	Capacitor	470 pF	-	10	1k	Cer	DEBB33A471KC1B	Murata
34	C2	Capacitor	150 nF	-	10	400	Poly	NRM-S154K400F	NIC
35	C3	Capacitor	150 nF	-	10	400	Poly	NRM-S154K400F	NIC
36	C4	Capacitor	150 nF	-	10	400	Poly	NRM-S154K400F	NIC
37	C5	Capacitor	4.7 μ F	-	10	63	Poly	B32560J475K	Epcos
38	C6	Capacitor	2200 μ F	105°	10	25	Free	2222 021 16222	Vishay

Table 3. Bill of materials 230 V (AC) ...continued

Part No.	Ref.	Part	Value or part no.	Power (W)	Tol. (%)	Volt (V)	Package	Type	Manufacturer
39	C7	Capacitor	4.7 μ F	105°	10	25	Free	-	-
40	C8	Capacitor	330 pF	Y1 type	5	-	Cer, Free	-	-
41	C9	Capacitor	10 μ F	105°	10	25	Free	-	-
42	C10	Capacitor	2.2 nF	-	10	4k	Cer	DECE33J222ZC4B	Murata
43	C11	Capacitor	10 nF	-	10	25	Cer, Free	-	-
44	L1	Inductor	680 μ H	-	-	-	-	744776268	Würth
45	L2	Inductor	330 μ H	-	-	-	-	744776233	Würth
46	L3	Inductor	100 μ H	-	-	-	-	74477120	Würth
47	TX1	Transformer	N87/3F3	-	-	-	EFD25	750340505	Würth
48	D1	Rect. Bridge	2 A	-	-	-	SO-4	DBLS205G	Taiwan semi
49	D2	TVS diode	-	600	-	400	-	P6KE400A	Fairchild
50	D3	Diode	1 A	-	-	800	-	HER107	Taiwan semi
51	D4	Zener	-	3	-	220	-	BZT03-C220	Vishay
52	D5	Diode	1 A	-	-	800	-	HER107	Taiwan semi
53	D6	Diode	3 A	-	-	100	-	SK310A	Taiwan semi
54	D7	Diode	1 A	-	-	800	-	HER107	Taiwan semi
55	D8	Zener	-	-	5	30	-	BZV55-C30	NXP
56	D9	Zener	-	-	5	20	-	BZV55-C20	NXP
57	D10	Diode	-	-	-	75	-	1N4148	NXP
58	Q1	Transistor	NPN	-	-	-	-	BC847B	NXP
59	Q2	Transistor	NPN	-	-	-	-	BC847B	NXP
60	Q3	Transistor	PNP	-	-	-	-	ZTX758	Zetex
61	ISO2	Opto-coupler	-	-	-	-	-	CNY17-1	Fairchild
62	U1	IC	-	-	-	-	SO-20W	SSL2102T	NXP

Table 4. Bill of materials 120 V (AC)

Part No.	Ref.	Part	Value or part no.	Power (W)	Tole. (%)	Volt (V)	Package	Type	Manufacturer
1	K1	Conn 3 pin 2	m	-	-	-	-	SL 5.08/3/90	Weidmuller
2	K1'	Conn 3 pin 2	f	-	-	-	-	BL 5.08/3	Weidmuller
3	K3	Conn 6 pin 1	f	-	-	-	-	BL3.36Z	Fischer
4	K2	Conn 2 pin 2	m	-	-	-	-	SL 5.08/2/90	Weidmuller
5	K2'	Conn 2 pin 2	f	-	-	-	-	BL 5.08/2	Weidmuller
6	F1	Fusistor	6.8 Ω	1	10	-	Free	-	-
7	R1	Resistor	27 Ω	1	5	-	Free	-	-
8	R2	Resistor	27 Ω	1	5	-	Free	-	-
9	R3	Resistor	2.7 k Ω	1	5	-	Free	-	-
10	R4	Resistor	470 k Ω	0.25	1	-	Free	-	-
11	R5	Resistor	0 Ω	0.25	5	-	Free	-	-
12	R6	Resistor	2.7 k Ω	1	5	200	Free	-	-
13	R7	Resistor	2.7 k Ω	1	5	200	Free	-	-
14	R8	Resistor	1 k Ω	1	5	200	Free	-	-
15	R9	Resistor	1 k Ω	1	5	200	Free	-	-
16	R10	Resistor	0.4 Ω	1	1	-	Free	-	-
17	R11	Resistor	33 k Ω	0.25	5	200	Free	-	-
18	R12	Resistor	10 Ω	1	5	200	Free	-	-
19	R13	Resistor	100 k Ω	0.1	1	200	Free	-	-
20	R14	Resistor	15 k Ω	0.1	1	-	Free	-	-
21	R15	Resistor	470 k Ω	0.1	1	-	Free	-	-
22	R16	Resistor	10 k Ω	0.1	1	-	Free	-	-
23	R17	Resistor	12 k Ω	0.1	1	-	Free	-	-
24	R18	Resistor	0.3 Ω	1	1	-	Free	-	-
25	R19	Resistor	10 k Ω	0.1	5	-	Free	-	-
26	R20	Resistor	50 k Ω Lin	0.1	5	-	Horizontal	-	Bourns
27	R21	Resistor	22 k Ω	0.1	1	-	Free	-	-
28	R22	Resistor	330 Ω	0.1	1	-	Free	-	-
29	R23	Resistor	3.9 k Ω	0.25	5	-	Free	-	-
30	R24	Resistor	3.9 k Ω	0.1	5	-	Free	-	-
31	R25	Resistor	100 k Ω	0.25	5	-	Free	-	-
32	R26	Resistor	NP	-	-	-	Free	-	-
33	C1	Capacitor	470 pF	-	10	1k	Cer	DEBB33A471KC1B	Murata
34	C2	Capacitor	100 nF	-	10	400	Poly	NRM-S104K400F	NIC
35	C3	Capacitor	330 nF	-	10	400	Poly	NRM-S334K400F	NIC
36	C4	Capacitor	330 nF	-	10	400	Poly	NRM-S334K400F	NIC
37	C5	Capacitor	4.7 μ F	-	10	63	Poly	B32560J475K	Epcos
38	C6	Capacitor	2200 μ F	105°	10	25	-	2222 021 16222	Vishay
39	C7	Capacitor	4.7 μ F	105°	10	25	Free	-	-
40	C8	Capacitor	330 pF	-	5	-	Cer, Free	-	-

Table 4. Bill of materials 120 V (AC) ...continued

Part No.	Ref.	Part	Value or part no.	Power (W)	Tole. (%)	Volt (V)	Package	Type	Manufacturer
41	C9	Capacitor	10 μ F	105°	10	25	Free	-	-
42	C10	Capacitor	2.2 nF	Y1 type	10	4k	Cer	DECE33J222ZC4B	Murata
43	C11	Capacitor	10 nF	-	10	25	Cer, Free		
44	L1	Inductor	680 μ H	-	-	-	-	744776268	Würth
45	L2	Inductor	330 μ H	-	-	-	-	744776233	Würth
46	L3	Inductor	100 μ H	-	-	-	-	74477120	Würth
47	TX1	Transformer	N87/3F3	-	5	-	EFD25	750340505	Würth
48	D1	Rect Bridge	2 A	-	-	-	SO-4	DBLS205G	Taiwan semi
49	D2	TVS diode	-	600	-	270	-	P6KE270A	Fairchild
50	D3	Diode	1 A	-	-	800	-	HER107	Taiwan semi
51	D4	Zener	-	3	-	220	-	BZT03-C220	Vishay
52	D5	Diode	1 A	-	-	800	-	HER107	Taiwan semi
53	D6	Diode	3 A	-	-	100	-	SK310A	Taiwan semi
54	D7	Diode	1 A	-	-	800	-	HER107	Taiwan semi
55	D8	Zener	-	-	5	30	-	BZV55-C30	NXP
56	D9	Zener	-	-	5	20	-	BZV55-C20	NXP
57	D10	Diode	-	-	-	75	-	1N4148	NXP
58	Q1	Transistor	NPN	-	-	-	-	BC847B	NXP
59	Q2	Transistor	NPN	-	-	-	-	BC847B	NXP
60	Q3	Transistor	PNP	-	-	-	-	MPSA92	NXP
61	ISO2	Opto-coupler	-	-	-	-	-	CNY17-1	Fairchild
62	U1	IC	-	-	-	-	SO-20W	SSL2102T	NXP

11. Transformer specification

Figure 9 shows the transformer schematic:

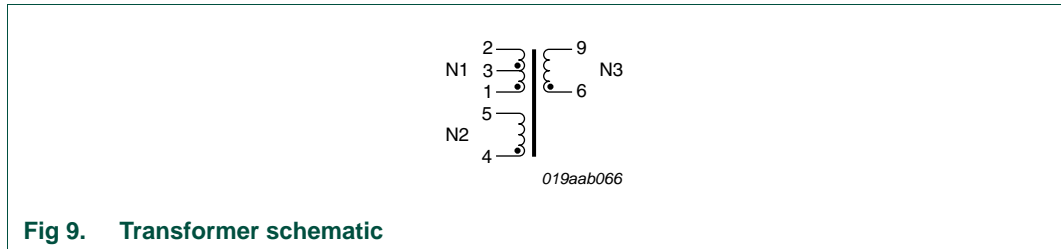

Fig 9. Transformer schematic

11.1 Turns ratio

- $(1 - 2) : (4 - 5) = 1 : 0.494 \pm 2 \%$
- $(1 - 2) : (6 - 9) = 1 : 0.247 \pm 2 \%$

11.2 Electrical characteristics

Table 5. Inductance

Section	Inductance
N1	1.08 mH $\pm 7 \%$, at 1.6 A
N2	70 μ H
N3	270 μ H

- Nominal frequency = 100 kHz

11.3 Core and bobbin1 x

- Core: EFD25, 3F3/N87, air gap center 1100 μ m
- Bobbin: CSH-EFD25-1S-10P

11.4 Physical dimensions

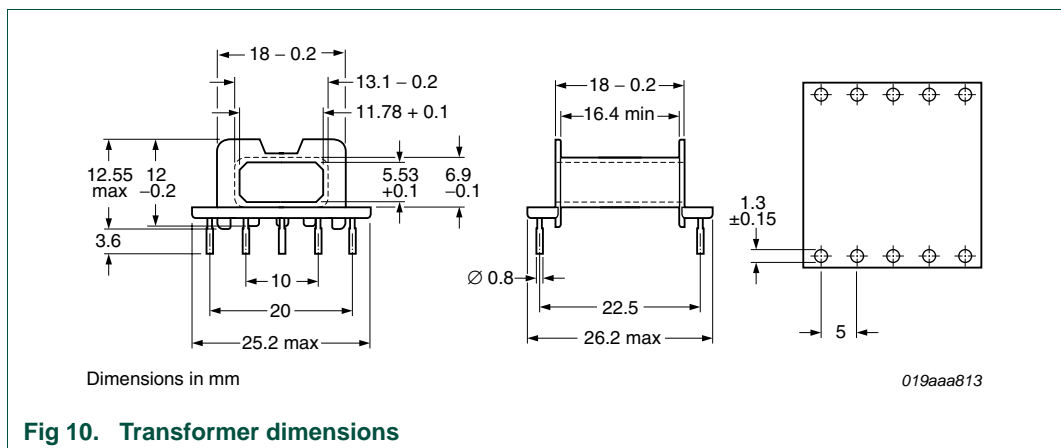
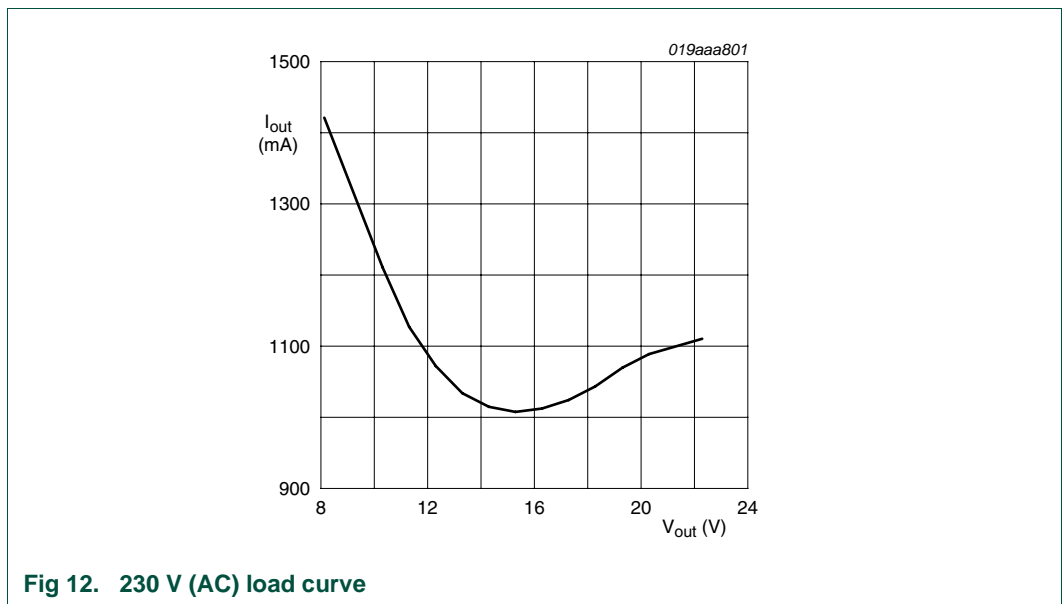
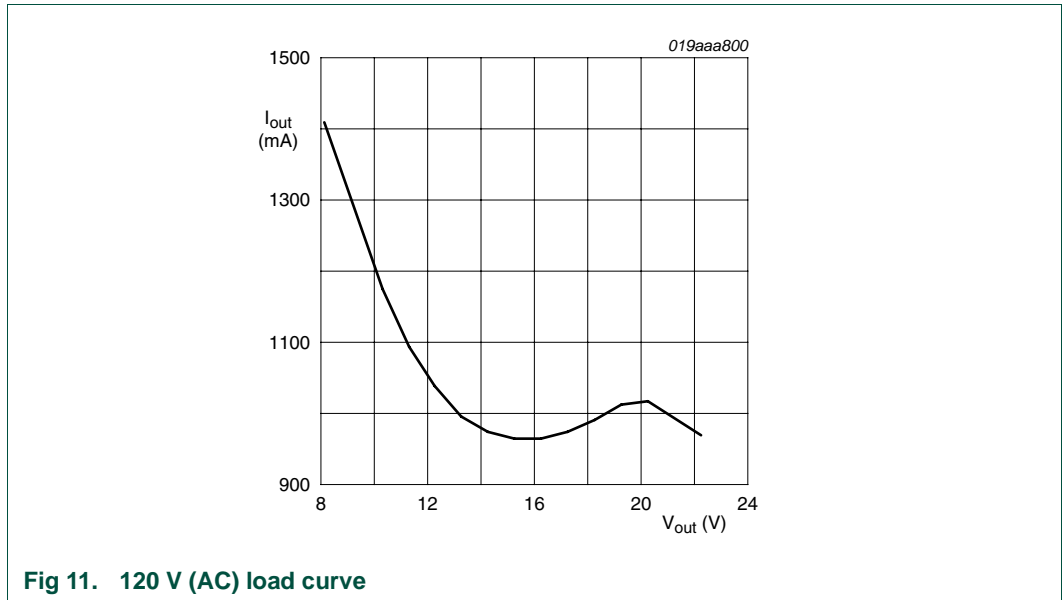
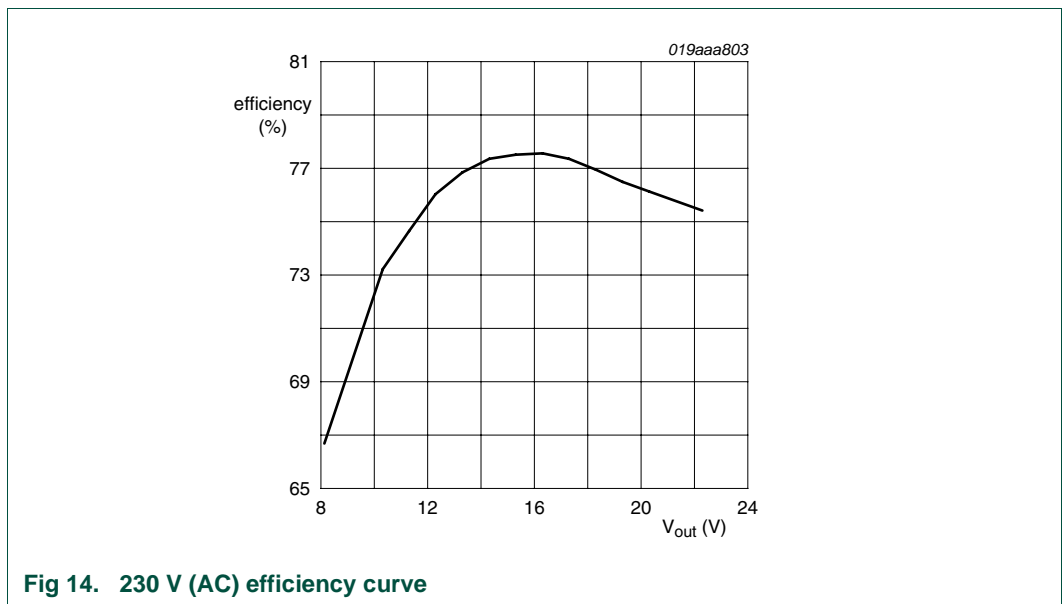
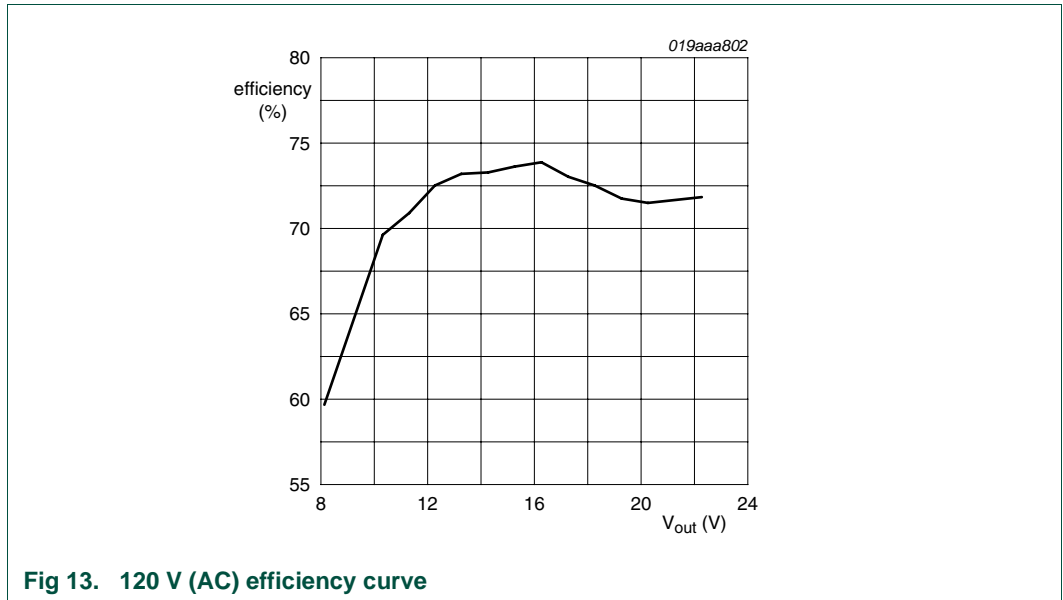

Fig 10. Transformer dimensions

12. Appendix A - Load curves



13. Appendix B - Efficiency curves



14. Appendix C - Input voltage dependency

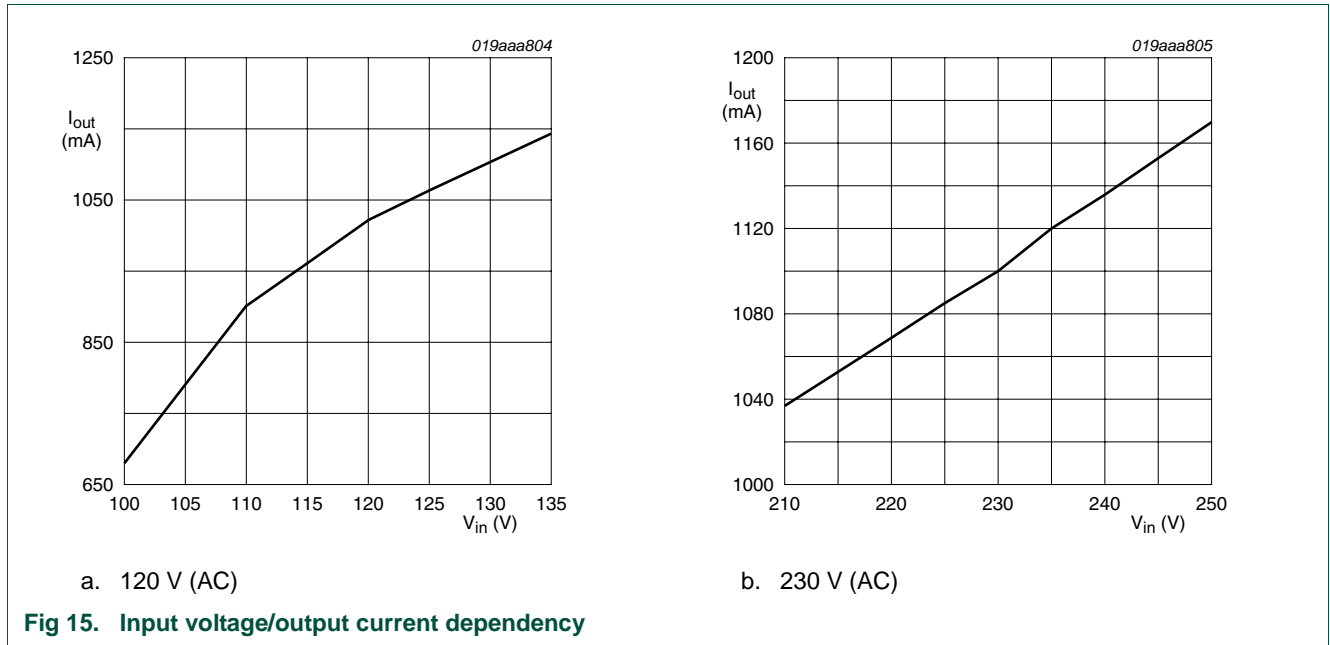

15. Appendix D - Mains conducted harmonics

Table 6. Mains conducted harmonic values

Harmonic	230 V (AC) 50 Hz amplitude (%)	120 V (AC) 60 Hz amplitude (%)
PF	0.97	0.99
1	100	100
2	0	0
3	13.6	10.7
4	0	0
5	5.5	3.7
6	0	0
7	1.6	0.9
8	0.2	0
9	2.5	1.9
10	0	0
11	1.1	0.6
12	0	0
13	2.5	1.7
14	0	0
15	1.7	1.1
16	0	0
17	0.9	0.2
18	0	0.1
19	2.9	0.8
20	0	0

16. References

- [1] **AN10831** — SSL2102 30 W flyback TRIAC dimmable LED driver
- [2] **AN10754** — SSL2101 and SSL2102 dimmable mains LED driver

17. Legal information

17.1 Definitions

Draft — The document is a draft version only. The content is still under internal review and subject to formal approval, which may result in modifications or additions. NXP Semiconductors does not give any representations or warranties as to the accuracy or completeness of information included herein and shall have no liability for the consequences of use of such information.

17.2 Disclaimers

Limited warranty and liability — Information in this document is believed to be accurate and reliable. However, NXP Semiconductors does not give any representations or warranties, expressed or implied, as to the accuracy or completeness of such information and shall have no liability for the consequences of use of such information.

In no event shall NXP Semiconductors be liable for any indirect, incidental, punitive, special or consequential damages (including - without limitation - lost profits, lost savings, business interruption, costs related to the removal or replacement of any products or rework charges) whether or not such damages are based on tort (including negligence), warranty, breach of contract or any other legal theory.

Notwithstanding any damages that customer might incur for any reason whatsoever, NXP Semiconductors' aggregate and cumulative liability towards customer for the products described herein shall be limited in accordance with the *Terms and conditions of commercial sale* of NXP Semiconductors.

Right to make changes — NXP Semiconductors reserves the right to make changes to information published in this document, including without limitation specifications and product descriptions, at any time and without notice. This document supersedes and replaces all information supplied prior to the publication hereof.

Suitability for use — NXP Semiconductors products are not designed, authorized or warranted to be suitable for use in life support, life-critical or safety-critical systems or equipment, nor in applications where failure or malfunction of an NXP Semiconductors product can reasonably be expected to result in personal injury, death or severe property or environmental damage. NXP Semiconductors accepts no liability for inclusion and/or use of NXP Semiconductors products in such equipment or applications and therefore such inclusion and/or use is at the customer's own risk.

Applications — Applications that are described herein for any of these products are for illustrative purposes only. NXP Semiconductors makes no representation or warranty that such applications will be suitable for the specified use without further testing or modification.

Customers are responsible for the design and operation of their applications and products using NXP Semiconductors products, and NXP Semiconductors accepts no liability for any assistance with applications or customer product design. It is customer's sole responsibility to determine whether the NXP Semiconductors product is suitable and fit for the customer's applications and products planned, as well as for the planned application and use of customer's third party customer(s). Customers should provide appropriate design and operating safeguards to minimize the risks associated with their applications and products.

NXP Semiconductors does not accept any liability related to any default, damage, costs or problem which is based on any weakness or default in the customer's applications or products, or the application or use by customer's third party customer(s). Customer is responsible for doing all necessary testing for the customer's applications and products using NXP Semiconductors products in order to avoid a default of the applications and the products or of the application or use by customer's third party customer(s). NXP does not accept any liability in this respect.

Export control — This document as well as the item(s) described herein may be subject to export control regulations. Export might require a prior authorization from national authorities.

Evaluation products — This product is provided on an "as is" and "with all faults" basis for evaluation purposes only. NXP Semiconductors, its affiliates and their suppliers expressly disclaim all warranties, whether express, implied or statutory, including but not limited to the implied warranties of non-infringement, merchantability and fitness for a particular purpose. The entire risk as to the quality, or arising out of the use or performance, of this product remains with customer.

In no event shall NXP Semiconductors, its affiliates or their suppliers be liable to customer for any special, indirect, consequential, punitive or incidental damages (including without limitation damages for loss of business, business interruption, loss of use, loss of data or information, and the like) arising out of the use of or inability to use the product, whether or not based on tort (including negligence), strict liability, breach of contract, breach of warranty or any other theory, even if advised of the possibility of such damages.

Notwithstanding any damages that customer might incur for any reason whatsoever (including without limitation, all damages referenced above and all direct or general damages), the entire liability of NXP Semiconductors, its affiliates and their suppliers and customer's exclusive remedy for all of the foregoing shall be limited to actual damages incurred by customer based on reasonable reliance up to the greater of the amount actually paid by customer for the product or five dollars (US\$5.00). The foregoing limitations, exclusions and disclaimers shall apply to the maximum extent permitted by applicable law, even if any remedy fails of its essential purpose.

Safety of high-voltage evaluation products — The non-insulated high voltages that are present when operating this product, constitute a risk of electric shock, personal injury, death and/or ignition of fire. This product is intended for evaluation purposes only. It shall be operated in a designated test area by personnel that is qualified according to local requirements and labor laws to work with non-insulated mains voltages and high-voltage circuits.

The product does not comply with IEC 60950 based national or regional safety standards. NXP Semiconductors does not accept any liability for damages incurred due to inappropriate use of this product or related to non-insulated high voltages. Any use of this product is at customer's own risk and liability. The customer shall fully indemnify and hold harmless NXP Semiconductors from any liability, damages and claims resulting from the use of the product.

17.3 Trademarks

Notice: All referenced brands, product names, service names and trademarks are the property of their respective owners.

18. Contents

1	Introduction	3
2	Safety warning	3
3	Connecting the board	4
4	Specifications	5
5	Board photos	6
6	Dimmers	7
7	Functional description	8
8	Board optimization	11
8.1	Changing the output voltage and LED current	11
8.2	Changing the output ripple current	11
8.3	Adapting to high power reverse phase (transistor) dimmers	11
8.4	Changing the load curve	12
8.5	Multiple driver support	12
9	Board schematic	13
10	Bill Of Materials (BOM)	14
11	Transformer specification	18
11.1	Turns ratio	18
11.2	Electrical characteristics	18
11.3	Core and bobbin ¹ x	18
11.4	Physical dimensions	18
12	Appendix A - Load curves	19
13	Appendix B - Efficiency curves	20
14	Appendix C - Input voltage dependency	21
15	Appendix D - Mains conducted harmonics . .	22
16	References	22
17	Legal information	23
17.1	Definitions	23
17.2	Disclaimers	23
17.3	Trademarks	23
18	Contents	24

Please be aware that important notices concerning this document and the product(s) described herein, have been included in section 'Legal information'.

© NXP B.V. 2011.

All rights reserved.

For more information, please visit: <http://www.nxp.com>

For sales office addresses, please send an email to: salesaddresses@nxp.com

Date of release: 1 February 2011

Document identifier: UM10386